

Data Sheet

GB-Series with pressure-fit flange SSI

Magnetostrictive Linear Position Sensors

- High pressure resistant sensor rod
- High operating temperature up to +100 °C (+212 °F)
- Flat & compact – ideal for the valve market

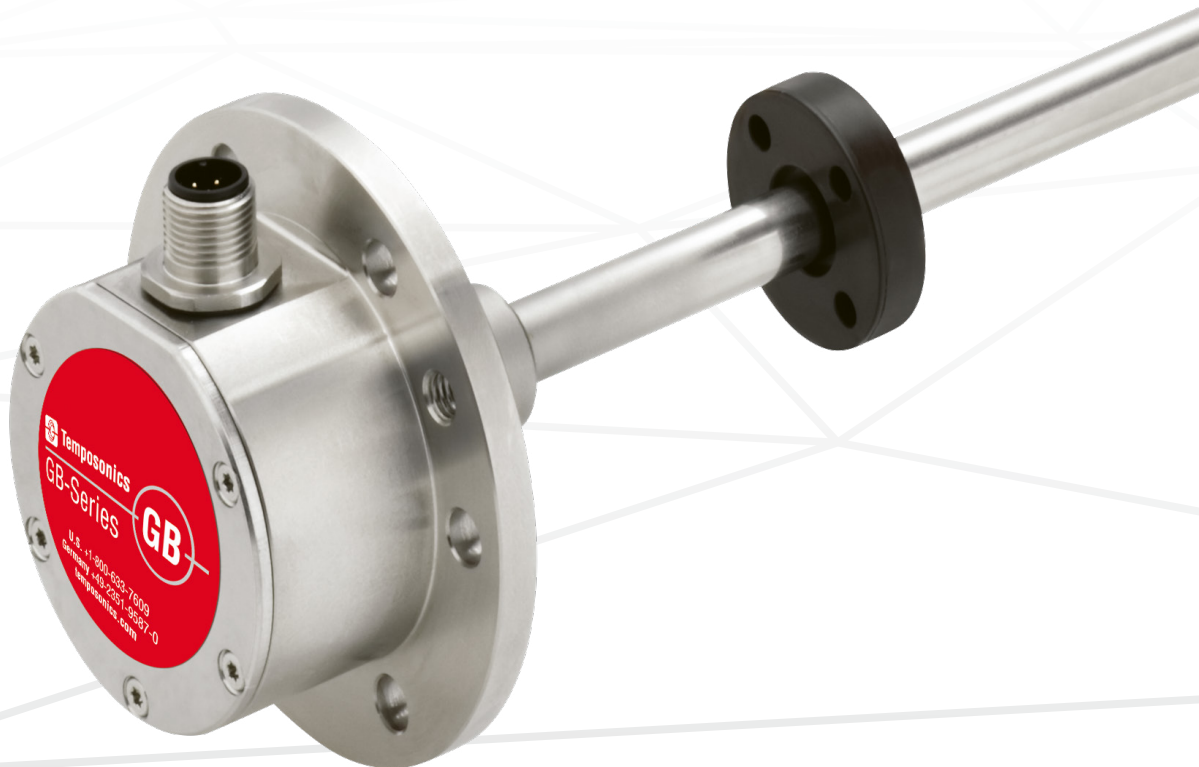

MEASURING TECHNOLOGY

The absolute, linear position sensors provided by Temposonics rely on the company's proprietary magnetostrictive technology, which can determine position with a high level of precision and robustness. Each Temposonics position sensor consists of a ferromagnetic waveguide, a position magnet, a strain pulse converter and supporting electronics. The magnet, connected to the object in motion in the application, generates a magnetic field at its location on the waveguide. A short current pulse is applied to the waveguide. This creates a momentary radial magnetic field and torsional strain on the waveguide. The momentary interaction of the magnetic fields releases a torsional strain pulse that propagates the length of the waveguide. When the ultrasonic wave reaches the end of the waveguide it is converted into an electrical signal. Since the speed of the ultrasonic wave in the waveguide is precisely known, the time required to receive the return signal can be converted into a linear position measurement with both high accuracy and repeatability.

GB SENSOR

Robust, non-contact and wear free – the Temposonics linear position sensors provide best durability and accurate position measurement solutions in harsh industrial environments. The high quality of the in-house manufactured waveguide forms the basis for precise measurements. The position magnet is mounted on the moving machine part and travels non-contact over the sensor rod with the built-in waveguide.

Temposonics® GB is a rod-style sensor for installation into hydraulic cylinders, e.g. in power engineering. With its flat and compact sensor housing and side-mounted signal connection, the sensor is ideal for small spaces. Due to the pressure-resistant sensor rod and its high operating temperature the Temposonics® GB sensor is perfectly suitable for use in fluid technology. For improved signal quality the sensor automatically adapts to the strength of the magnet used in the application.

The set points, start and end position of the measurement, can be modified after installation of the Temposonics® GB sensor. Programming can be carried out using the standard connection cable.

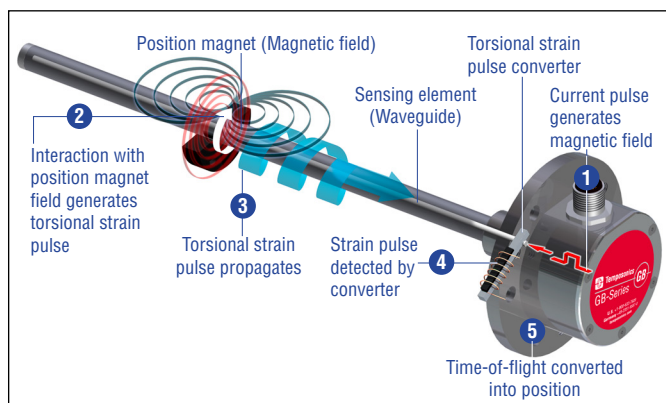

Fig. 1: Time-of-flight based magnetostrictive position sensing principle

TECHNICAL DATA

Output	
Interface	SSI (Synchronous Serial Interface) – Differential signal in SSI standard
Data format	Binary, gray
Data length	8...32 bit
Programming	Programming of set points using optional accessories
Measured value	Position
Measurement parameters	
Resolution	5 µm minimum
Cycle time	Up to 3.7 kHz depending on stroke length
Linearity ¹	≤ ±0.02 % F.S. (minimum ±60 µm) typical
Repeatability	≤ ±0.005 % F.S. (minimum ±20 µm) typical
Operating conditions	
Operating temperature	–40...+90 °C (–40...+194 °F), Options: –40...+75 °C (–40...+167 °F)/ –40...+100 °C (–40...+212 °F)
Ingress protection	IP67 (correctly fitted); IP68 (for cable outlet)
Shock test	100 g (single shock) IEC standard 60068-2-27
Vibration test	15 g/10...2000 Hz IEC standard 60068-2-6 (excluding resonant frequencies)
EMC test	Electromagnetic emission according to EN 61000-6-4 Electromagnetic immunity according to EN 61000-6-2 The sensor meets the requirements of the EU directives and is marked with CE
Operating pressure	350 bar (5,076 psi), 700 bar (10,153 psi) peak (at 10 × 1 min), GB-J: 800 bar (11,603 psi)
Magnet movement velocity	Any
Design/Material	
Sensor electronics housing ² with flange	GB-J/GB-K/GB-S: Stainless steel 1.4305 (AISI 303), GB-N: Stainless steel 1.4404 (AISI 316L)
Sensor rod	GB-J: Stainless steel 1.4301 (AISI 304), GB-K/GB-S: Stainless steel 1.4306; 1.4307 (AISI 304L), GB-N: Stainless steel 1.4404 (AISI 316L)
Stroke length	25...3250 mm (1...128 in.)
Mechanical mounting	
Mounting position	Any
Mounting instruction	Please consult the technical drawings and the operation manual (document number: 551631)
Electrical connection	
Connection type	M12 A-coded male connector (8 pin), M16 male connector (7 pin), cable outlet
Operating voltage	+24 VDC (–15/+20 %)
Ripple	≤ 0.28 V _{pp}
Current consumption	90 mA typical
Dielectric strength	500 VDC (DC ground to machine ground)
Polarity protection	Up to –30 VDC
Overvoltage protection	Up to 36 VDC

1/ With position magnet # 251 416-2

2/ For option **H** (–40...+100 °C/–40...+212 °F) an aluminum cover plate is used

TECHNICAL DRAWING

GB-N/GB-S, example: With M12 connector

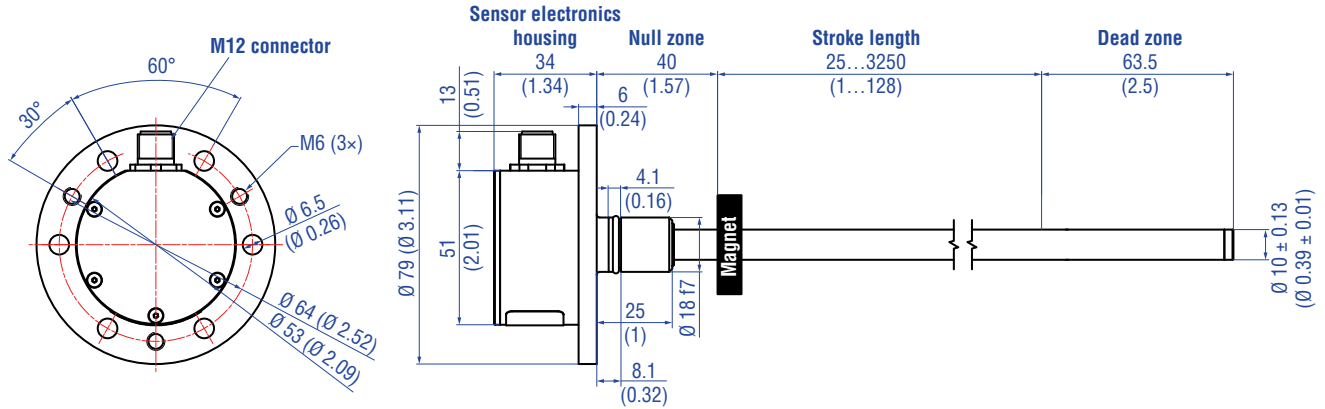

GB-K, example: With M16 connector

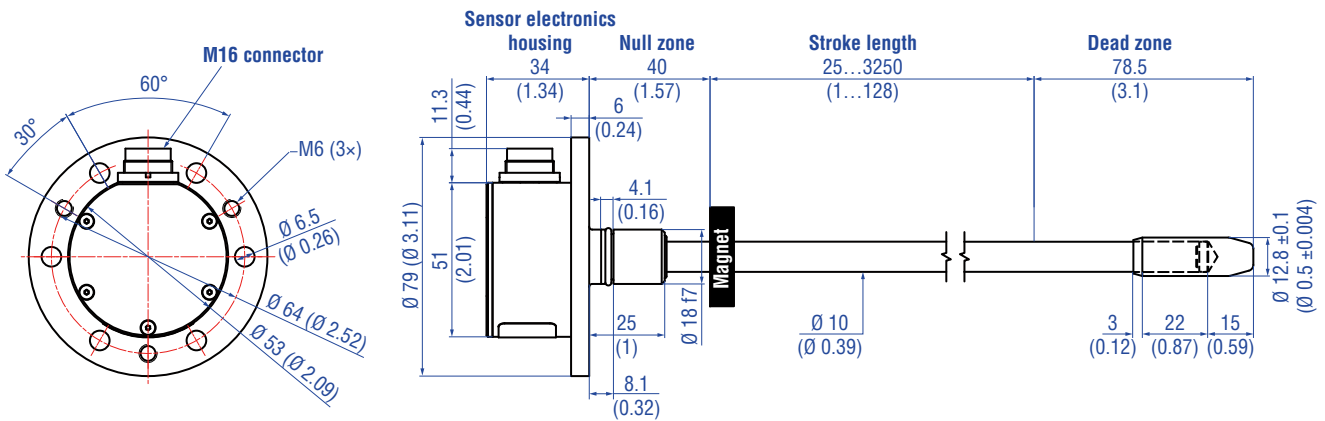

GB-J, example: With cable outlet

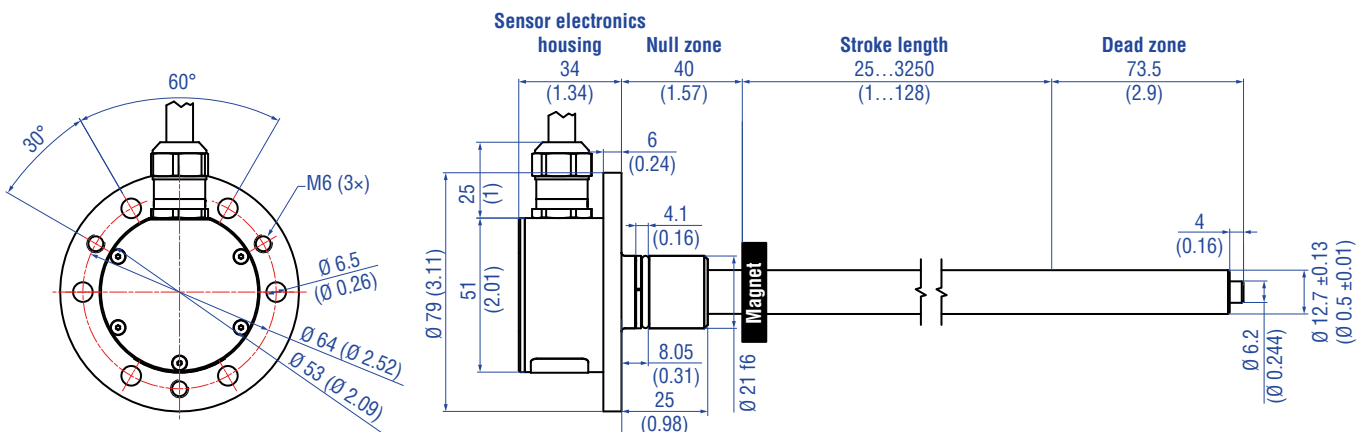

Controlling design dimensions are in millimeters and measurements in () are in inches

Fig. 2: Temposonics® GB-N/GB-S/GB-K/GB-J with ring magnet

CONNECTOR WIRING

D84		
Signal + power supply		
M12 male connector (A-coded)	Pin	Function
 <p>View on sensor</p>	1	Clock (+)
	2	Clock (-)
	3	Data (+)
	4	Data (-)
	5	Not connected
	6	Not connected
	7	+24 VDC (-15/+20 %)
	8	DC Ground (0 V)

Fig. 3: Connector wiring D84 (M12 connector)

D70		
Signal + power supply		
M16 male connector	Color	Function
 <p>View on sensor</p>	1	Data (-)
	2	Data (+)
	3	Clock (+)
	4	Clock (-)
	5	+24 VDC (-15/+20 %)
	6	DC Ground (0 V)
	7	Not connected

Fig. 4: Connector wiring D70 (M16 connector)

GB with cable outlet (HXX / TXX / VXX)		
Signal + power supply		
Cable	Color	Function
	GY	Data (-)
	PK	Data (+)
	YE	Clock (+)
	GN	Clock (-)
	BN	+24 VDC (-15/+20 %)
	WH	DC Ground (0 V)

For cable type TXX, the extra red & blue wires are not used.

Fig. 5: Connector wiring (cable outlet)

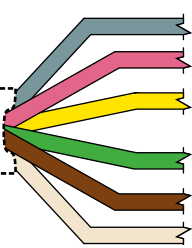
FREQUENTLY ORDERED ACCESSORIES – Additional options available in our [Accessories Guide](#)  [551444](#)

Position magnets

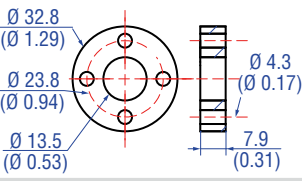
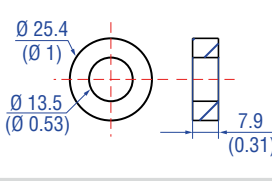
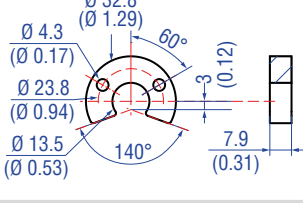
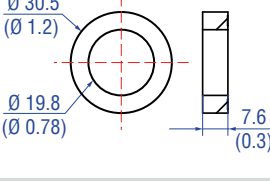
			
<p>Ring magnet OD33 Part no. 201 542-2</p> <p>Material: PA ferrite GF20 Weight: Approx. 14 g Surface pressure: Max. 40 N/mm² Fastening torque for M4 screws: 1 Nm Operating temperature: -40...+105 °C (-40...+221 °F)</p>	<p>Ring magnet OD25.4 Part no. 400 533</p> <p>Material: PA ferrite Weight: Approx. 10 g Surface pressure: Max. 40 N/mm² Operating temperature: -40...+105 °C (-40...+221 °F)</p>	<p>U-magnet OD33 Part no. 251 416-2</p> <p>Material: PA ferrite GF20 Weight: Approx. 11 g Surface pressure: Max. 40 N/mm² Fastening torque for M4 screws: 1 Nm Operating temperature: -40...+105 °C (-40...+221 °F)</p>	<p>Ring magnet Part no. 402 316</p> <p>Material: PA ferrite coated Weight: Approx. 13 g Surface pressure: Max. 20 N/mm² Operating temperature: -40...+100 °C (-40...+212 °F)</p>

Position magnet O-rings Back-up ring

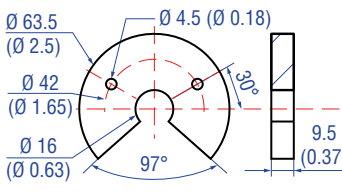
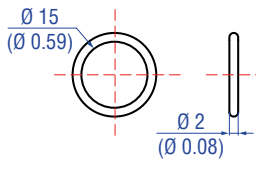
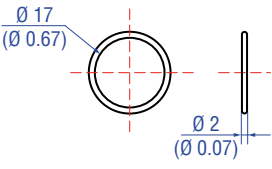
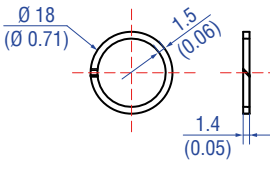
			
<p>U-magnet OD63.5 Part no. 201 553</p> <p>Material: PA 66-GF30, magnets compound-filled Weight: Approx. 26 g Surface pressure: 20 N/mm² Fastening torque for M4 screws: 1 Nm Operating temperature: -40...+75 °C (-40...+167 °F)</p>	<p>O-ring for pressure fit flange Ø 18 mm Part no. 560 853</p> <p>Material: Fluoroelastomer Durometer: 75 Shore A Operating temperature:</p>	<p>O-ring for pressure fit flange Ø 21 mm Part no. 561 438</p> <p>Material: FKM Durometer: 75 Shore A</p>	<p>Back-up ring for pressure fit flange Ø 18 mm Part no. 561 115</p> <p>Material: PTFE + 60 % bronze</p>

Back-up ring Optional installation hardware Magnet spacer

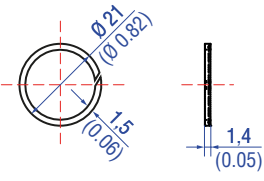
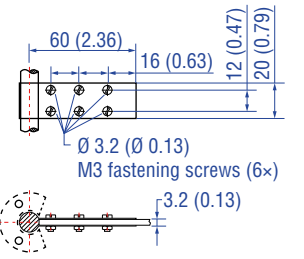
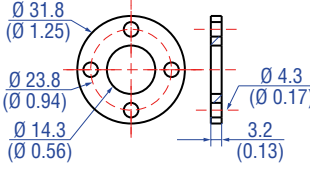

		
<p>Back-up ring for pressure fit flange Ø 21 mm Part no. 561 439</p> <p>Material: PTFE</p>	<p>Fixing clip Part no. 561 481</p> <p>Application: Used to secure sensor rods (Ø 10 mm (Ø 0.39 in.)) when using an U-magnet or block magnet Material: Brass, non-magnetic</p>	<p>Magnet spacer Part no. 400 633</p> <p>Material: Aluminum Weight: Approx. 5 g Surface pressure: Max. 20 N/mm² Fastening torque for M4 screws: 1 Nm</p>

Controlling design dimensions are in millimeters and measurements in () are in inches

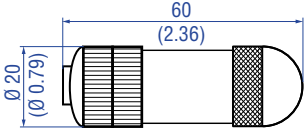
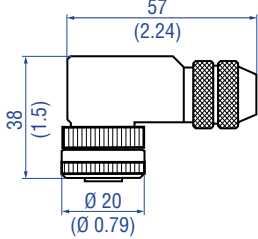
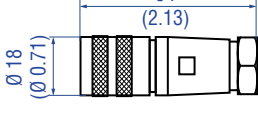
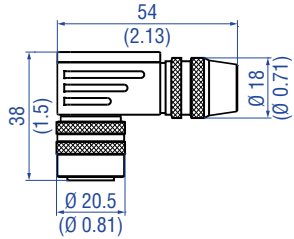
Cable connectors*

			
<p>M12 A-coded female connector (8 pin), straight Part no. 370 694</p> <p>Housing: GD-ZnAL Termination: Screw Contact insert: CuZn Cable Ø: 4...9 mm (0.16...0.35 in.) Wire: 0.75 mm² Operating temperature: -25...+90 °C (-13...+194 °F) Ingress protection: IP67 (correctly fitted) Fastening torque: 0.6 Nm</p>	<p>M12 A-coded female connector (8 pin), angled Part no. 370 699</p> <p>Housing: GD-ZnAL Termination: Screw Contact insert: CuZn Cable Ø: 6...8 mm (0.24...0.31 in.) Wire: 0.5 mm² Operating temperature: -25...+85 °C (-13...+185 °F) Ingress protection: IP67 (correctly fitted) Fastening torque: 0.6 Nm</p>	<p>M16 female connector (7 pin), straight Part no. 370 624</p> <p>Material: Zinc nickel plated Termination: Solder Contact insert: Silver plated Cable clamp: PG9 Cable Ø: 6...8 mm (0.24...0.31 in.) Operating temperature: -40...+100 °C (-40...+212 °F) Ingress protection: IP65/IP67 (correctly fitted) Fastening torque: 0.7 Nm</p>	<p>M16 female connector (7 pin), angled Part no. 560 779</p> <p>Material: Zinc nickel plated Termination: Solder Contact insert: Silver plated Cable Ø: 6...8 mm (0.24...0.31 in.) Wire: 0.75 mm² (20 AWG) Operating temperature: -40...+95 °C (-40...+203 °F) Ingress protection: IP67 (correctly fitted) Fastening torque: 0.5 Nm</p>

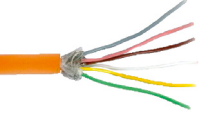
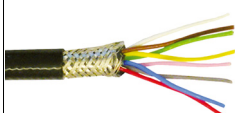
Cables

		
<p>PUR cable Part no. 530 052</p> <p>Material: PUR jacket; orange Features: Twisted pair, shielded, highly flexible, halogen free, suitable for drag chains, mostly oil & flame resistant Cable Ø: 6.4 mm (0.25 in.) Cross section: 3 × 2 × 0.25 mm² Bending radius: 5 × D (fixed installation) Operating temperature: -30...+80 °C (-22...+176 °F)</p>	<p>PTFE cable Part no. 530 112</p> <p>Material: PTFE jacket; black Features: Twisted pair, shielded, flexible, high thermal resistance, mostly oil & acid resistant Cable Ø: 7.6 mm (0.3 in.) Cross section: 4 × 2 × 0.25 mm² Bending radius: 8 – 10 × D (fixed installation) Operating temperature: -100...+180 °C (-148...+356 °F)</p>	<p>Silicone cable Part no. 530 113</p> <p>Material: Silicone jacket; red Features: Twisted pair, shielded, highly flexible, halogen free, high thermal resistance Cable Ø: 7.2 mm (0.28 in.) Cross section: 3 × 2 × 0.25 mm² Bending radius: 5 × D (fixed installation) Operating temperature: -50...+180 °C (-58...+356 °F)</p>

Programming tool

<p>Programming kit Part no. 254 590</p> <p>Kit includes: 1 × interface converter box, 1 × power supply 1 × cable (60 cm) with M12 female connector (8 pin), straight – D-sub female connector (9 pin), straight 1 × cable (60 cm) with M16 female connector (7 pin), straight – D-sub female connector (9 pin), straight 1 × cable (60 cm) with 6 × terminal clamp – D-sub female connector (9 pin), straight 1 × USB cable</p> <p>Software is available at: www.temposonics.com</p>

*/ Follow the manufacturer's mounting instructions

Controlling design dimensions are in millimeters and measurements in () are in inches

Temposonics® GB-Series with pressure-fit flange SSI

Data Sheet

ORDER CODE

1	2	3	4	5	6	7	8	9	10	11	12	13	14	15	16	17	18	19	20	21
G	B										1	S								C
a	b	c						d			e	f						g	h	

a	Sensor model
G B	Rod

b	Design
J	Housing material stainless steel 1.4305 (AISI 303), rod material stainless steel 1.4301 (AISI 304) Pressure fit flange Ø 21 mm, Ø 12.7 mm rod, 800 bar
K	Housing material stainless steel 1.4305 (AISI 303), rod material stainless steel 1.4306; 1.4307 (AISI 304L) Pressure fit flange Ø 18 mm, Ø 10 mm rod with bushing on rod end
N	Housing material stainless steel 1.4404 (AISI 316L), rod material stainless steel 1.4404 (AISI 316L) ³ Pressure fit flange Ø 18 mm, Ø 10 mm rod
S	Housing material stainless steel 1.4305 (AISI 303), rod material stainless steel 1.4306; 1.4307 (AISI 304L) Pressure fit flange Ø 18 mm, Ø 10 mm rod

c	Stroke length
X X X X M	0025...3250 mm
Standard stroke length (mm) Ordering steps	
25... 500 mm	5 mm
500... 750 mm	10 mm
750...1000 mm	25 mm
1000...2500 mm	50 mm
2500...3250 mm	100 mm
X X X X U	001.0...128.0 in.
Standard stroke length (in.) Ordering steps	
1... 20 in.	0.2 in.
20... 30 in.	0.4 in.
30... 40 in.	1.0 in.
40...100 in.	2.0 in.
100...128 in.	4.0 in.
Non-standard stroke lengths are available; must be encoded in 5 mm/0.1 in. increments.	

d	Connection type
D 8 4	M12 connector (8 pin)
D 7 0	M16 connector (7 pin)
H X X	PUR cable (part no. 530 052) (suitable for max. operating temperature of +80 °C (+176 °F)) H01...H10 (1...10 m/3...33 ft.) See "Frequently ordered accessories" for cable specifications

d	Connection type (continued)
T X X	PTFE cable (part no. 530 112) T01...T10 (1...10 m/3...33 ft.) See "Frequently ordered accessories" for cable specifications
V X X	Silicone cable (part no. 530 113) V01...V10 (1...10 m/3...33 ft.) See "Frequently ordered accessories" for cable specifications
Encode in meters if using metric stroke length. Encode in feet if using US customary stroke length	

e	Operating voltage
1	+24 VDC (-15/+20 %)

f	Output
S (14) (15) (16) (17) (18) (19) = Synchronous Serial Interface	
Data length (box no. 14)	
1	25 bit
2	24 bit
Output format (box no. 15)	
B	Binary
G	Gray
Resolution (box no. 16)	
1	0.005 mm (5 µm)
2	0.01 mm (10 µm)
3	0.05 mm (50 µm)
4	0.1 mm (100 µm)
5	0.02 mm (20 µm)
Filtering performance (box no. 17)	
1	No filter
2	Average filter 2
3	Average filter 4
4	Average filter 8
Signal options (box no. 18, 19)	
0 0	Measuring direction forward, asynchronous measurement
0 1	Measuring direction reverse, asynchronous measurement
0 2	Measuring direction forward, synchronised measurement
0 3	Measuring direction reverse, synchronised measurement

g See next page

3/ The sensor in stainless steel 1.4404 (AISI 316L) is only available with following options: S (-40...+90 °C (-40...+194 °F)) & L (-40...+75 °C (-40...+167 °F))

g	Operating temperature
H	-40...+100 °C (-40...+212 °F)
S	-40...+90 °C (-40...+194 °F)
L	-40...+75 °C (-40...+167 °F)

h	Programming
C	Via cable

DELIVERY



- Sensor
- O-ring
- Back-up ring

Accessories have to be ordered separately.

Manuals, Software & 3D Models available at:
www.temposonics.com

UNITED STATES
Temposonics, LLC
Americas & APAC Region
3001 Sheldon Drive
Cary, N.C. 27513
Phone: +1 919 677-0100
E-mail: info.us@temposonics.com

GERMANY
Temposonics
GmbH & Co. KG
EMEA Region & India
Auf dem Schüffel 9
58513 Lüdenscheid
Phone: +49 2351 9587-0
E-mail: info.de@temposonics.com

ITALY
Branch Office
Phone: +39 030 988 3819
E-mail: info.it@temposonics.com

FRANCE
Branch Office
Phone: +33 6 14 060 728
E-mail: info.fr@temposonics.com

UK
Branch Office
Phone: +44 79 44 15 03 00
E-mail: info.uk@temposonics.com

SCANDINAVIA
Branch Office
Phone: + 46 70 29 91 281
E-mail: info.sca@temposonics.com

CHINA
Branch Office
Phone: +86 21 2415 1000 / 2415 1001
E-mail: info.cn@temposonics.com

JAPAN
Branch Office
Phone: +81 3 6416 1063
E-mail: info.jp@temposonics.com

Document Part No.
551630 Revision E (EN) 02/2022



temposonics.com